

ROOM • KITCHEN • BATHROOM • HALLWAY

DETAILS

that matter



Down to the smallest detail

A room tells you who you are. So let the details take their place and become part of the feeling. We have door handles, knobs, fittings and lighting for every room in life. Our ambition is to foresee trends and changes in style and interior decoration, and keep track of the very latest, as well as the classics. Dream details for the bedroom and tasteful details for the kitchen. That withstands touch and lasts for many years. Details that matter.

On the cover: Knob T Viva, page 12

On the left: Knob T Viva and Handle Viva, page 12

Follow us for more inspiration and latest news



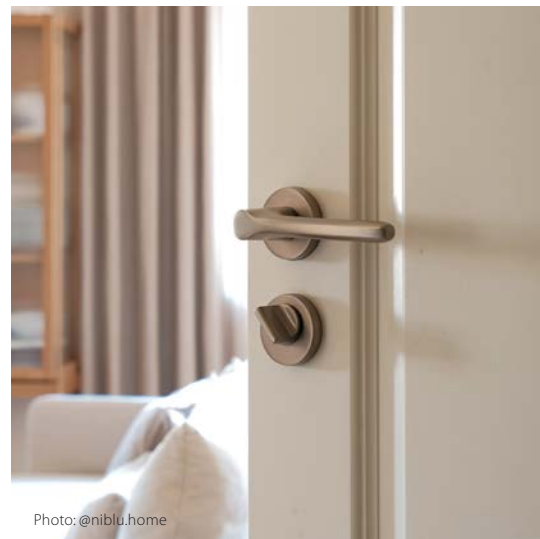

Innehåll

NATURE'S OWN COLORS	6
KITCHEN	10
ROOM	40
BATHROOM	50
HALLWAY	58

Beslag Design AB
 Inre Kustvägen 32, 269 43 Båstad
 Sweden
 + 46 431-784 80
 info@beslagdesign.se
 beslagdesign.com

We reserve the right for possible printing errors and color differences compared to the original in the catalog.

Båstad Februari 2025



SEA

A dramatic and powerful blue shade inspired by the depths of the ocean. Storm Blue exudes a sense of strength and elegance, making it perfect for creating a striking detail in your home or project.



BEACH

A soft and subtle gray-beige hue reminiscent of sandy beaches. Limestone Gray is a versatile color that brings a light and airy feel, making it ideal for both modern and classic interiors.

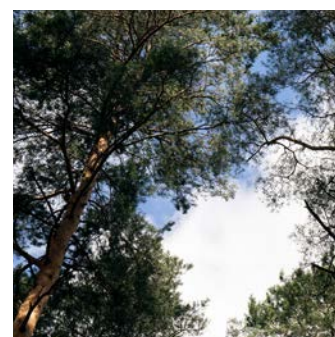

FOREST

A calming and natural green tone that evokes peaceful forest clearings. Sage Green adds a fresh and vibrant atmosphere, perfect for bringing the tranquility of nature into your home or project.

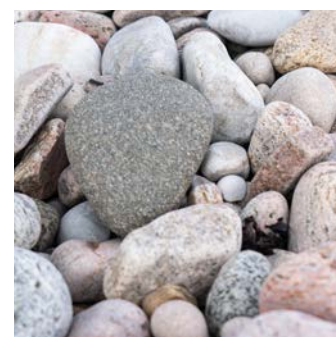

STONE

A deep and elegant shade reminiscent of the soft hue of stone. Graphite Gray creates a sophisticated and timeless ambiance, ideal for modern and minimalist interiors.

Nature's own colours

- 1. KNOB T VIVA ● STORM BLUE ● LIMESTONE GREY ● SAGE GREEN ● GRAPHITE GREY
- 2. KNOB SKYE ● STORM BLUE ● LIMESTONE GREY ● SAGE GREEN ● GRAPHITE GREY
- 3. PROFIL HANDLE SIDE – C/C 20 OCH 2X60 ● STORM BLUE ● LIMESTONE GREY ● SAGE GREEN ● GRAPHITE GREY
- 4. HANDLE VIVA – C/C 128 OCH 160 ● STORM BLUE ● LIMESTONE GREY ● SAGE GREEN ● GRAPHITE GREY



Storm blue

A powerful and elegant blue hue, inspired by the depths of the ocean.



Choosing blue in the kitchen is a great way to create a fresh, inviting, and timeless atmosphere. Here are a few reasons why blue is a fantastic choice for your kitchen:

1. Creates calm and harmony.

Blue is known for its calming and stress-relieving properties. By incorporating blue tones in the kitchen, you can create a harmonious space that feels welcoming and soothing — perfect for both cooking and socializing.

2. Timeless and versatile.

Blue is a classic color that never goes out of style. Whether you choose a light sky blue or a deep navy hue, you can be sure your kitchen will feel both modern and timeless.

3. Easy to combine.

Blue is a versatile color that pairs beautifully with various materials and other colors. Combine blue with natural wood for a warm and inviting feel, or with white and stainless steel for a fresh, modern look.

Blue in the kitchen is more than just a color – it's an experience that creates a space you'll love to be in!

4. Enhances the details.

Blue is the perfect backdrop that truly allows the details to shine. Handles and knobs in materials like brass, matte black, or stainless steel stand out beautifully against blue kitchen cabinets.

5. A personal touch.

A blue kitchen feels unique and personal. With so many shades of blue, from soft pastels to dark and dramatic tones, you can choose the hue that best reflects your style and taste.

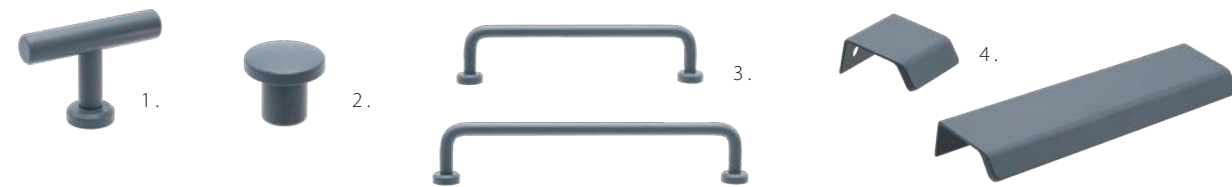

1. KNOB T VIVA 2. KNOB SKYE 3. HANDLE VIVA – C/C 128 OCH 160 4. PROFIL HANDLE SIDE – C/C 20 OCH 2X60



NAVY BLUE • COBALT BLUE • OCEAN BLUE • STEEL BLUE • POWDER BLUE • MIDNIGHT BLUE • TURQUOISE BLUE • MISTY BLUE • ICE BLUE • PETROL BLUE • ROYAL BLUE • AZURE BLUE • FRENCH BLUE • DENIM BLUE

KITCHEN

DETAILS THAT LAST A LIFETIME

The kitchen is the heart of the home, where life is constantly unfolding. A place that is shaped by hands of all ages – from those covered in soil after gardening to those dusted with flour after baking.

Our products are carefully designed to harmonize with different styles and needs. They can soften the expression or give a more distinct character, standing out as details or blending seamlessly into the whole. Whether it's handles, lighting, accessories, or storage, they are crafted to withstand daily use and endure over time.

Function meets timeless design.

A bright and sleek kitchen where function meets timeless design. The white kitchen creates a spacious feel, while the Solliden knob and brass details add warmth and elegance. The light marble countertop enhances the sophisticated impression and provides practical workspace. With smart storage and generous surfaces, the kitchen becomes a harmonious space for both cooking and socializing.

Photo and styling: @mwinteriordesign.se

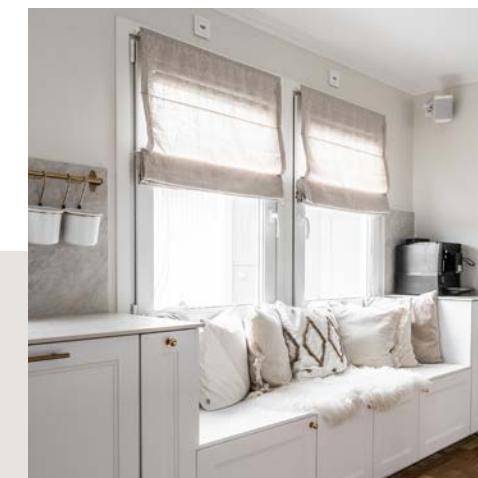

Solliden
Polished brass – Art no 339431-11

NEW IN

Viva in metall.

Viva combines a classic shape with modern design, making it a perfect fit for any environment – from kitchens and bathrooms to hallways and public spaces. With its elegant and versatile style, Viva is available as both a handle and a T-knob, making it a flexible choice for every room.

Viva comes in several sophisticated metal finishes, such as brushed brass and brushed stainless steel, complementing all interior styles. It is also available in Beslag Design's nature-inspired colors, where the classic forms are given new life with a contemporary touch. Discover the full collection and let the colors of nature bring harmony and warmth to your home.

See Viva in Nature's own colors on page 7.

Viva



- 1. Polished brass
- 2. Brushed brass
- 3. Burnished brass
- 4. Polished chrome
- 5. Brushed stainless steel
- 6. Matte black



NEW IN



Fits into all types of interiors.

The Viva handle combines a timeless shape with modern design, making it a perfect fit for all types of interiors – whether in the kitchen, bathroom, or hallway. With its elegant and versatile style, Viva is an excellent choice for both home and public spaces.

Viva is available in several sleek metal finishes: matte black, brushed brass, polished chrome, polished brass, and brushed stainless steel — colors that complement all interior styles. Easily create a cohesive and stylish decor with the Viva knob.

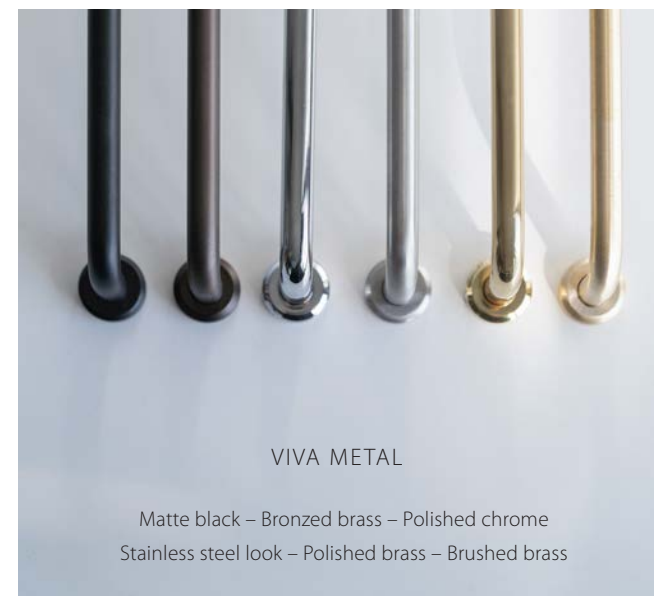

NEW IN



Viva – an excellent choice.

A modern kitchen where natural materials meet contemporary design. The beautiful alder wood and limestone countertop create a warm and inviting atmosphere. The Viva handles and stainless steel provide a sleek contrast, enhancing the modern expression.

The kitchen island, with its rounded corners, softens the lines and balances the solid character of the kitchen. It serves as both a practical workspace and a natural gathering point. A harmonious kitchen where functionality and aesthetics come together to create a timeless whole.

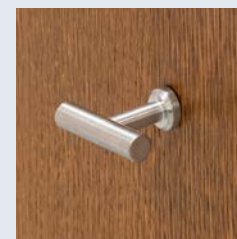

Brushed stainless steel
 Handle Viva c/c 160 mm – 304391-11
 Knob T Viva – 304401-11

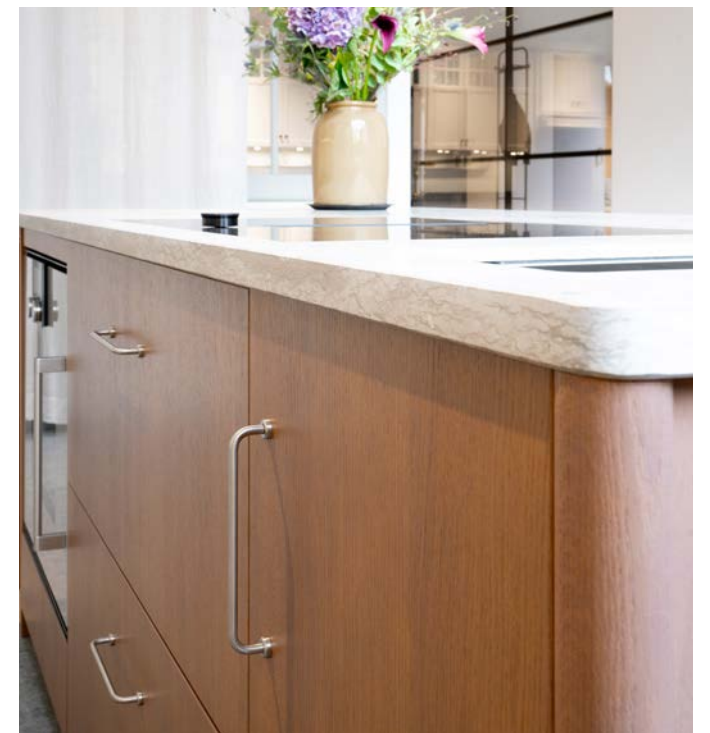
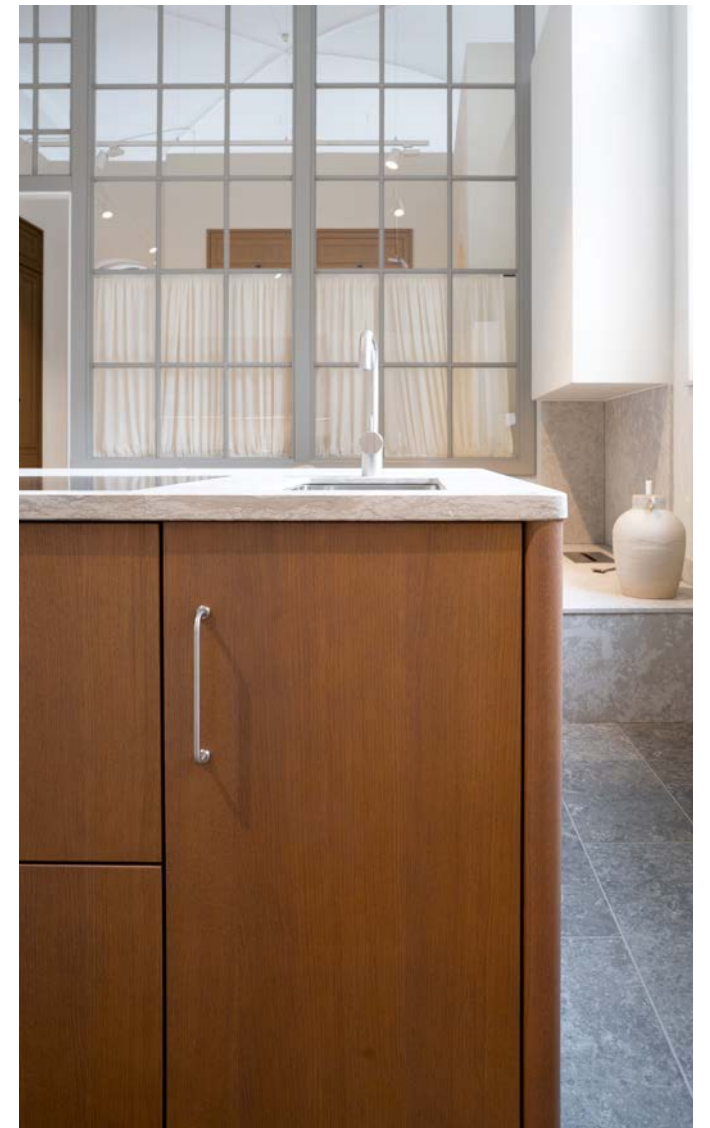



“Finally, we have lighting in the pantry.”

PHOTOGRAPHER
AND
INTERIOR
DESIGNER

@lovisafurubo

One of our ambassadors, Lovisa, shares her experience working with Beslag Design.

“It feels really exciting! I’ve been looking for ways to incorporate more and better functionality into many parts of my home, so it’s really fun that it’s finally becoming a reality! The heart of Beslag Design is quality, sustainability, and aesthetics, which align perfectly with my own values. When it comes to style, I think many people assume that Beslag Design only offers modern hardware, but there is actually so much beautiful classic style as well.”

Lighting in the pantry.

LED Stripe Flexy LED AT6. Art no 973642



Polished untreated brass

Kitchen rail Aveny. Art no 948000-41

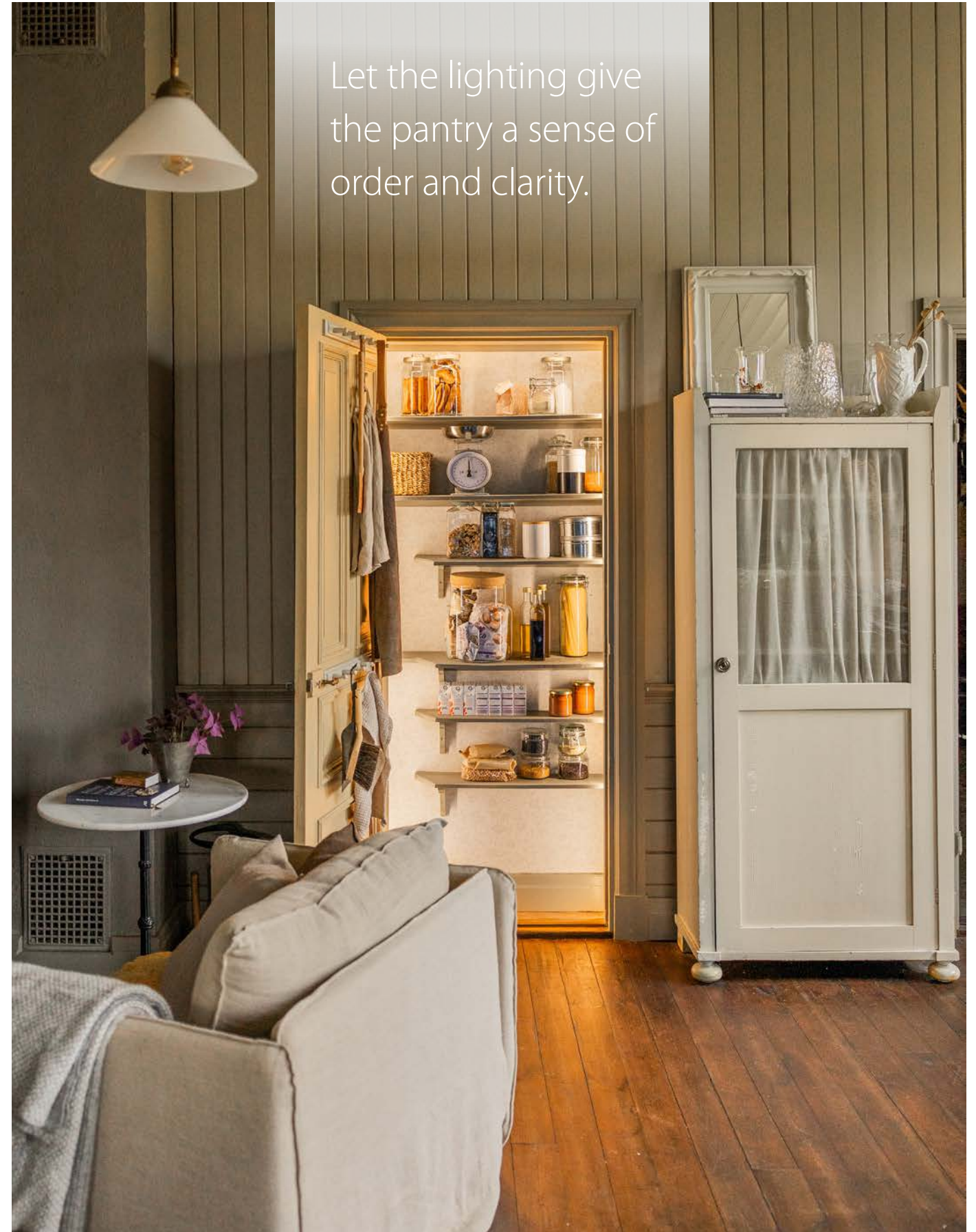

Let the lighting give the pantry a sense of order and clarity.

Photo: @lovisafurubo

Burnished brass

The burnished of brass creates a beautiful finish and a deeper, warmer tone that complements the rustic and vintage aesthetic. We've expanded our collection with burnished brass, now available on our popular Sture knob, the Lip profile handle, and the new Knob Oliver T.

● Details in burnished brass can be the perfect accent to create contrast.



1. Knob Sture 2. Knob Uno 3. Handle Lip 4. Handle Uniform 5. Knob T Uniform 6. Handle Viva 7. Knob T Viva

Uniform

Uniform is a series of modern and sleek knobs and handles, available in several different colors. With its burnished brass finish, it adds a unique and sophisticated touch that elevates both classic and modern interiors.

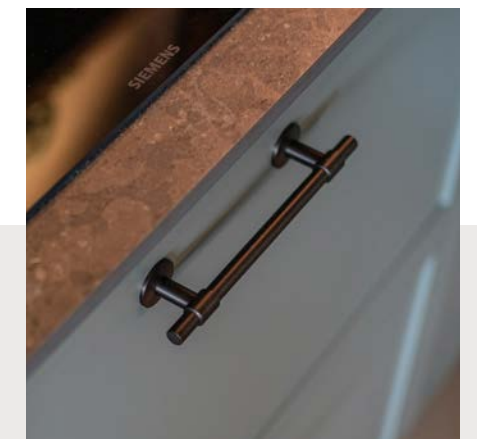
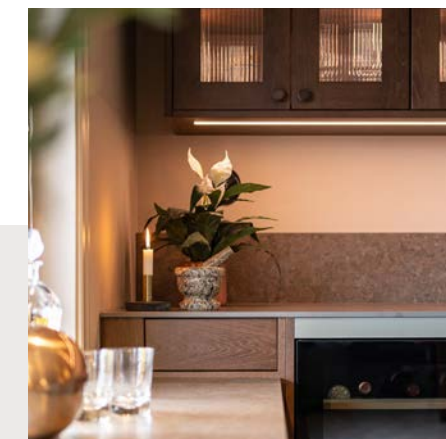
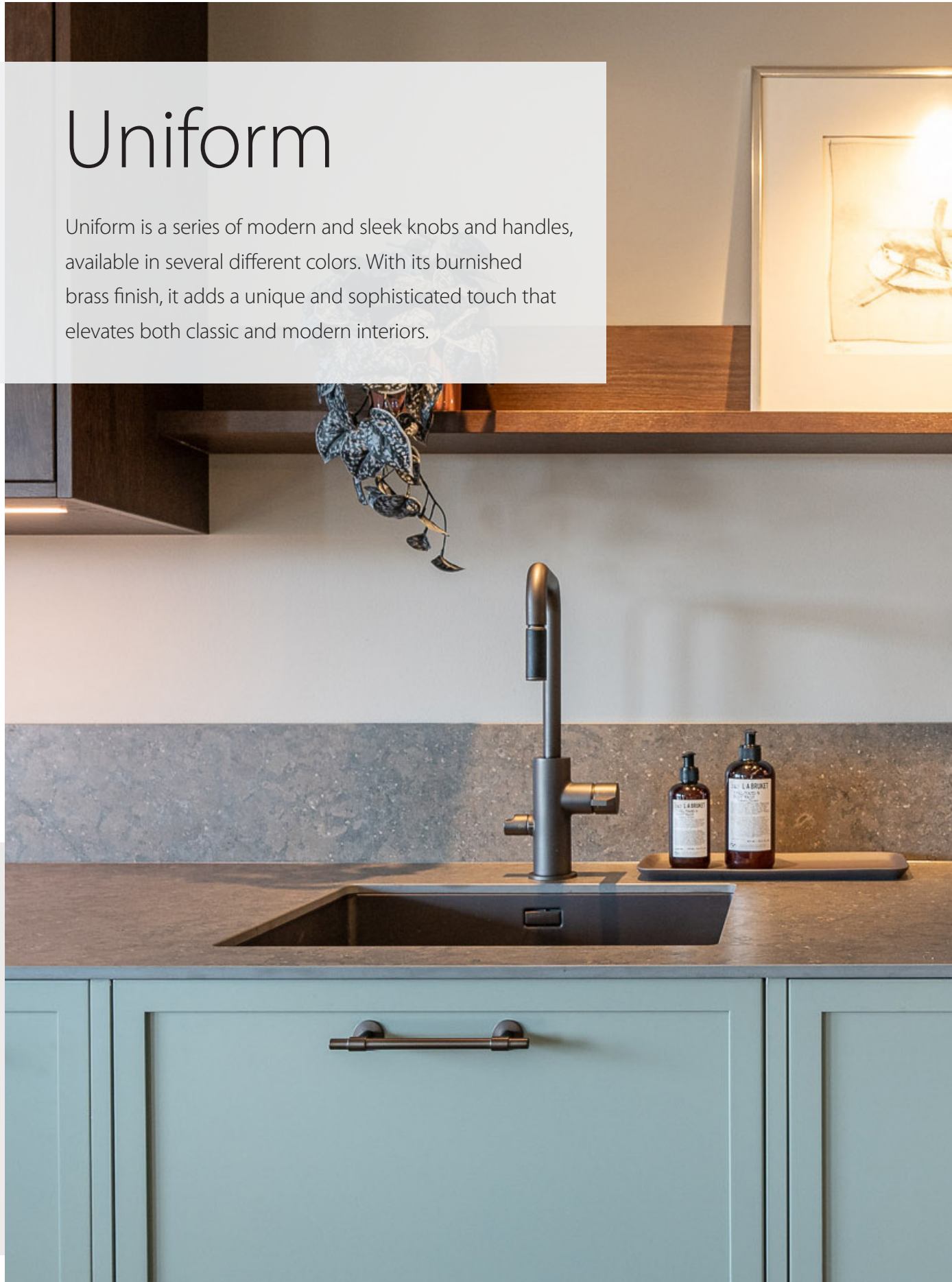

A subtle and warm feeling.

Still & Storm was tasked with completely renovating an apartment for a client with a clear request: it had to be "top of the line." With complete creative freedom, we chose Beslag Design and Claessons Kök to bring the vision to life. Our goal was to create an interior with a sophisticated, subtle, and warm feel.

Interior design and ideas: @stillstormab



Burnished brass
Handle Uniform c/c 160 mm. Art no 343305-11
Knob Uno. Art no 343309-11

Create a unified interior design.



Creating a unified style throughout your home or project can be challenging, but by selecting matching interior details such as knobs, handles, and door handles, you can achieve a harmonious and well-planned whole. We guide you through the process and show how Beslag Design can help you tie each room together with style and elegance.



1. Define the style.

To make it easier to choose hardware and interior details that create a cohesive style, it's important to define a clear interior style that runs throughout the entire home or project. Modern, minimalist, classic, industrial, Scandinavian, retro/functionalist, or rustic style?



2. Cohesive colors and materials.

A cohesive color palette and thoughtful material choices are essential for creating a unified feel and overall harmony. By selecting hardware and details based on colors and materials, you can ensure they seamlessly integrate into the entire home or project, complementing the overall interior style.

3. Matching details for every room.

Creating a common thread throughout different rooms is easy with Beslag Design's products. Small details like door handles, wardrobe knobs, drawer pulls, and kitchen handles can make a significant difference in how cohesive the space feels.

MINIMALIST STYLE.

A clean and simple style where monochrome color palettes, such as white, gray, and black, are combined with smooth and discreet hardware in nickel-plated, chrome, or matte black finishes. Light wood details also complement the minimalist style.



INDUSTRIAL STYLE.

A robust and raw feel with dark, earthy tones like charcoal gray, brown, and black, paired with hardware in burnished brass, stainless steel, or details with a textured surface. This style emphasizes strength and durability, creating a bold, industrial aesthetic with a touch of warmth and character.



COUNTRY STYLE.

Soft, nature-inspired colors like white, beige, and pastel shades are combined with hardware in antique brass or porcelain. These details create a warm and welcoming atmosphere in a rustic kitchen, adding both charm and comfort to the space.



NEW IN

Jubilee

We are expanding our Jubilee collection with a new, elegant finish in polished nickel.

Now, you have even more opportunities to create unique combinations and add a luxurious touch to your home.



Monica Förster x Beslag Design

Jubilee is a collection of knobs and handles created in collaboration with the acclaimed designer Monica Förster. The design draws inspiration from a classic hardware piece but with a unique expression, where history and the future are seamlessly intertwined.

Jubilee takes its cues from a historical design, but with a stronger presence and a distinctive voice. It is a tribute that allows the past and future to converge and be reinterpreted in the products. The industrial feel is both classic and contemporary, blending timeless elegance with modern functionality.

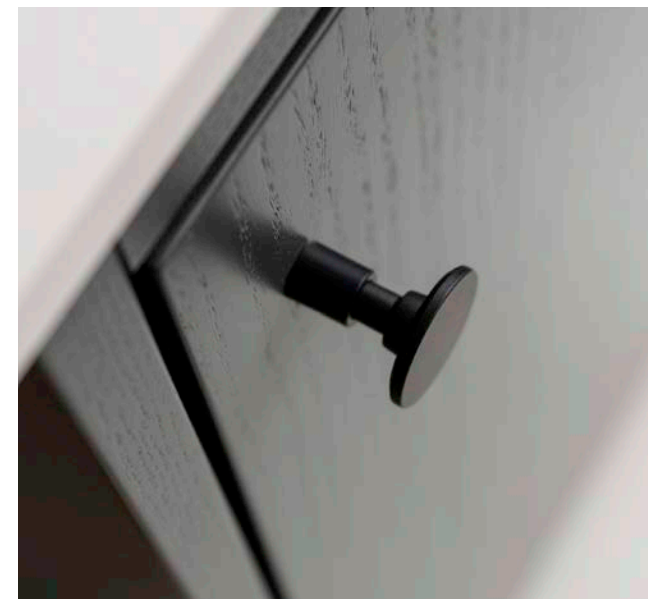

A sense of form and curiosity.

“Every project begins with a thought. An idea that evolves into a conceptual design. Only then do I focus on form and details. We combine the intuitive and craft-driven with the technical.”

I am constantly curious about how different materials can be used and how new combinations can be created.”

Knob and Handle Jubilee



Polished nickel, Matte black, and Untreated brass.





Jubilee in Untreated Brass

More beautiful with time.

Untreated brass is an authentic and living material that ages beautifully over time, developing a unique patina with use. As a historic and sustainable material, brass gains an extra luster when combined with light grey cabinets and oak details, highlighting its natural beauty. A light marble countertop complements the overall look, adding timeless elegance to the room.

Jubilee – aesthetic and Functional for every room.



Untreated brass

Handle Jubilee – c/c 160 mm. Art no 372011-41

Handle Jubilee – c/c 128 mm. Art no 372006-41

Knob Jubilee Ø28 mm. Art no 372001-41





Corner cabinet pull-out. Cornerstone Maxx Planero

Cornerstone Maxx Planero is a fully extendable storage solution for base cabinets that maximizes space in the corner cabinet. Both shelves glide smoothly and silently out of the cabinet, providing easy access to everything. Each shelf can be fixed at the desired height. With its lava gray color and sleek, smooth design with fully enclosed sides, Cornerstone Maxx Planero leaves a graceful impression. This corner carousel seamlessly integrates into modern kitchens and makes storage easily accessible.

There are two variants of the corner pull-out: right-hand and left-hand.

Right corner pull-out: Left-hinged door, pull-out from the right.
Left corner pull-out: Right-hinged door, pull-out from the left.

Both options provide easy access to the corner cabinet's hidden space, making organization and item retrieval easier. It is easier to organize and locate your items.

- Easy to install, even for retrofitting.
- EasyFit: Tool-free shelf installation.
- Soft-closing with damping.
- Easy height adjustment, even after installation.
- Hidden fastening creates the feeling of floating shelves.

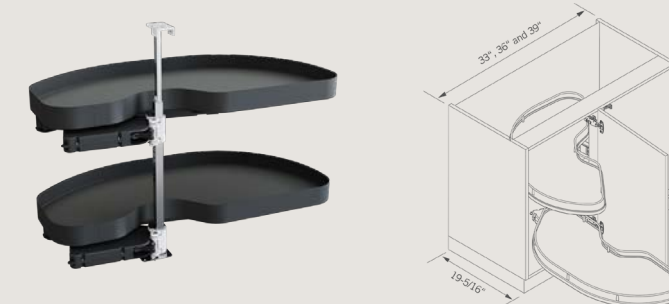

Cornerstone Maxx Planero – 800, 900, 1000 and 1200 mm
Available as right- or left-handed.

Knob 5320 - Nickel plated – 397911-11



A SELECTION OF OUR HANDLES & KNOBS.

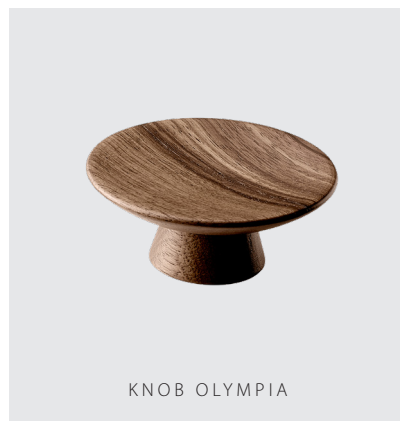
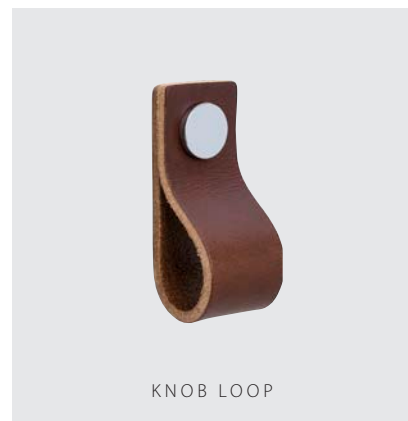
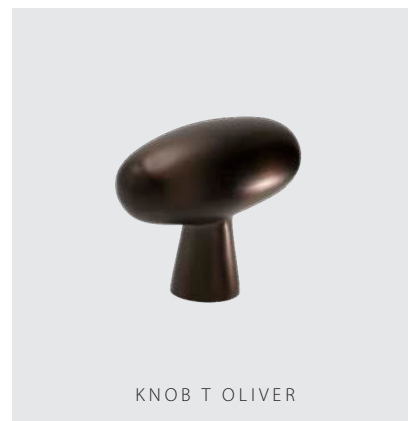
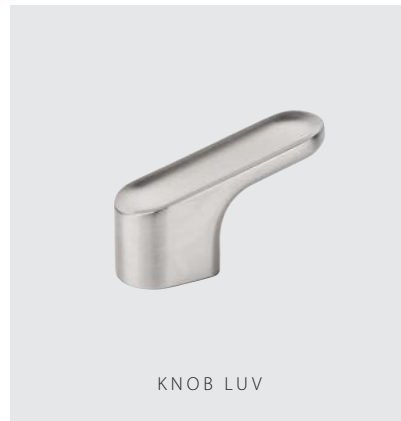

Charming RETRO STYLE.



Solliden in nickel-plated.

A sleek L-shaped kitchen filled with natural light and elegant details. Grey cabinets are paired with a marble countertop for a timeless and sophisticated feel.

The Solliden knob in nickel-plated adds a classic touch, while white tiles and the Bernadotte sconce provide harmonious lighting. The insides of the cabinets are carefully oiled with paraffin oil for a durable and fresh finish. The checkered grey and white floor ties the whole space together, giving the kitchen a charming retro style.

Photo: Funkiskök

Photograph: Emilia Ahlgren

Knob Solliden - Nickel plated. Art no 339430-11

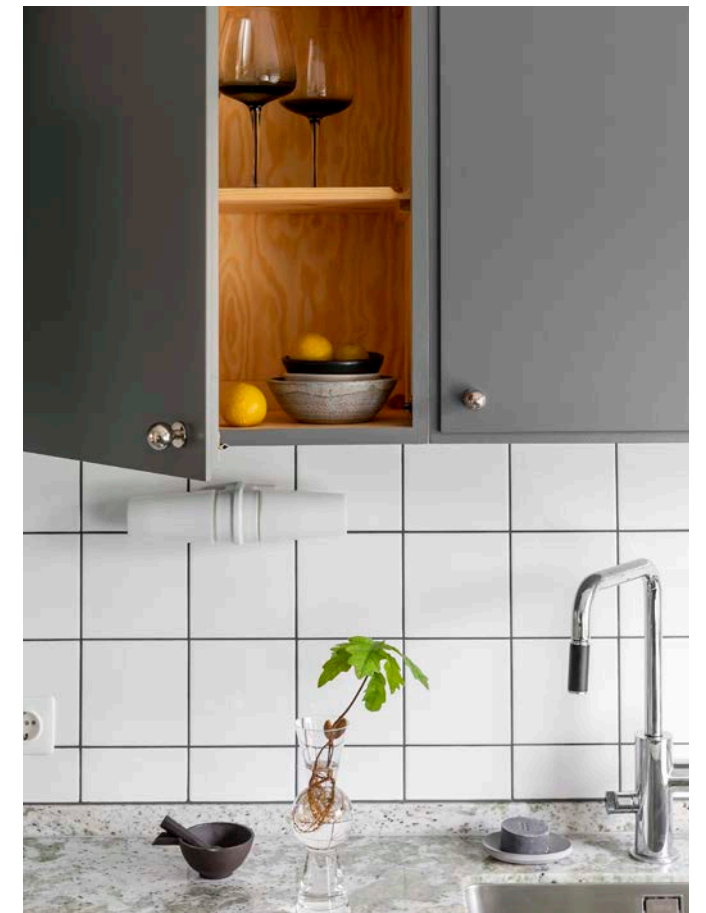

“With a beautifully crafted wooden kitchen rail from Beslag Design, this small wall is now complete!”

@emelie.sundberg

PHOTOGRAPH AND INFLUENCER



Kitchen rail Aveny

Aveny is an elegant and practical kitchen rail that adds both function and style to your kitchen. Mount it on the kitchen wall to easily store utensils, pot holders, or towels – or place it on the kitchen island for easy access to everything.

Made from untreated oak, Aveny not only provides a functional solution but also serves as a decorative detail that enhances the kitchen's atmosphere. The combination of the natural warmth of oak and the sleek matte black accents creates a harmonious and stylish feel in your kitchen.

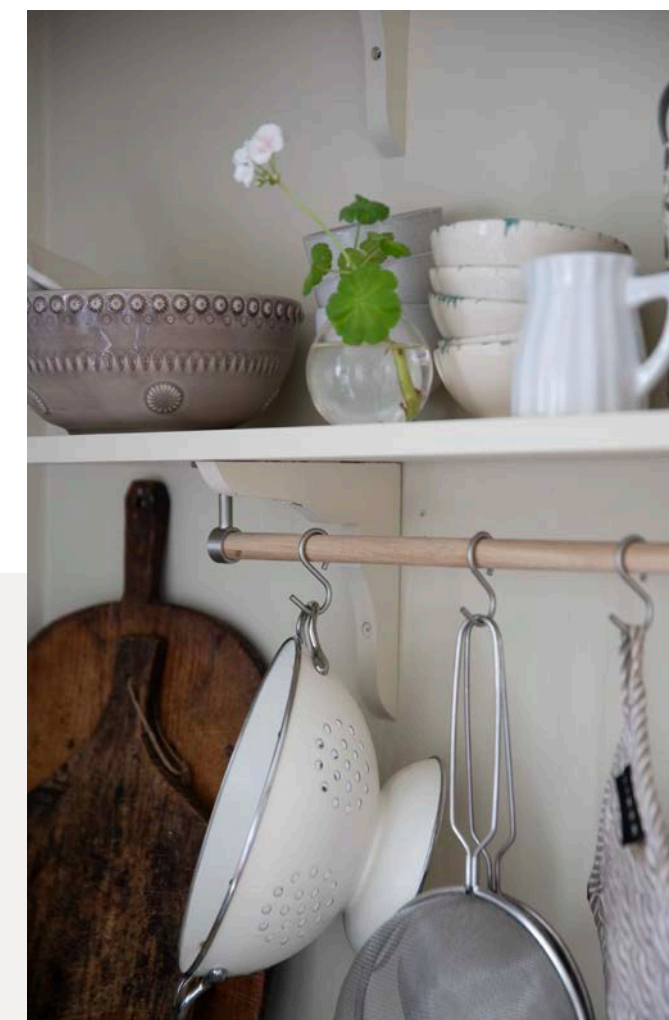

The rail is made of untreated oak.



- Polished untreated brass
- Matte black
- Brushed stainless steel

The rail is made of untreated oak, offering an honest and natural surface that ages beautifully over time and develops a unique patina. Each rod is one-of-a-kind in its color and texture, adding authenticity and individuality to your kitchen. By treating the rod with oil, lacquer, or paint, you can customize it to your personal taste, creating a cohesive look that blends seamlessly with your kitchen design. To preserve its natural beauty and extend its lifespan, we recommend treating the rod.

Aveny can be shortened to the desired length or extended using the extension kit. It comes with a 600 mm rail, 2 holders, wood screws, and 5 hooks. Additional hooks are also available for purchase.

Maximum load: 5 kg for a set with rail and 5 hooks.



Photo: @emelie.sundberg

Image to the left: Kitchen rail Aveny - 600 mm - Complete - Oak/Brushed Stainless Steel



Bond – for modern and classic environments

The Bond handle and knob in antique bronze/brushed brass combine elegance and functionality with a sleek, industrial feel reminiscent of workshops and machinery.

Every detail is meticulously designed to emphasize its robust construction and strong presence, creating a unique character that elevates both modern and classic interiors.

Also available in a matte black/gun metal finish.

Antique brown/brushed brass

Handle Bond – c/c 160 mm. Art no 352080-11

Knob T Bond . Art nr 352085-11





ROOM

A room tells the story of who you are.

Let the details take center stage and become part of the atmosphere. Complete the décor with that special touch and showcase your personality and temperament. Knobs, handles, and hardware for every room. Lighting, accessories, and storage solutions for homes, shops, offices, restaurants, and hotels.

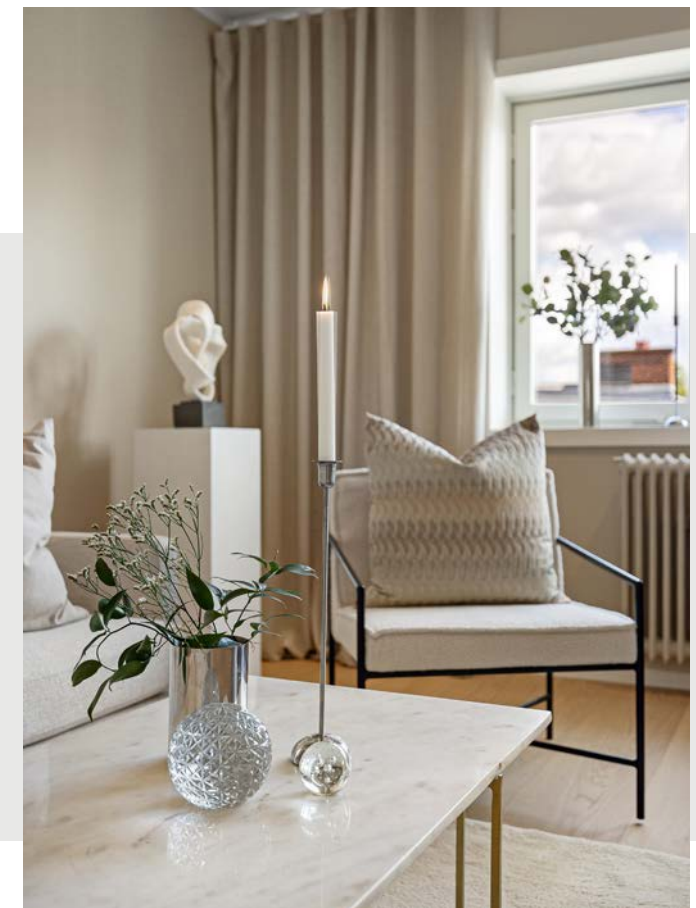
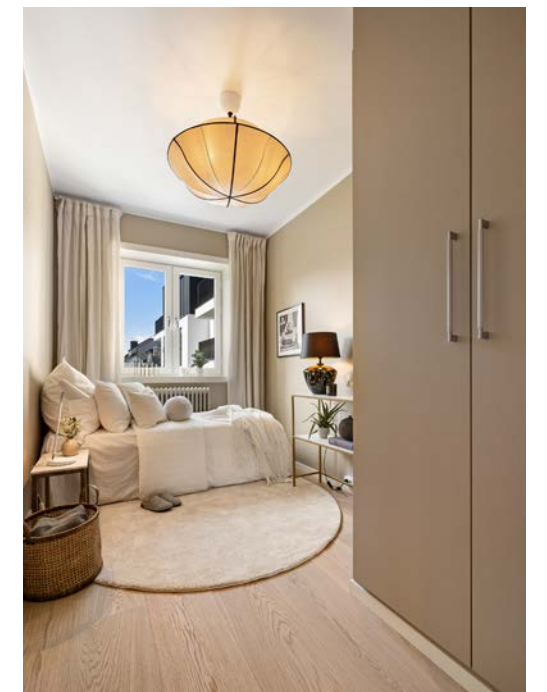
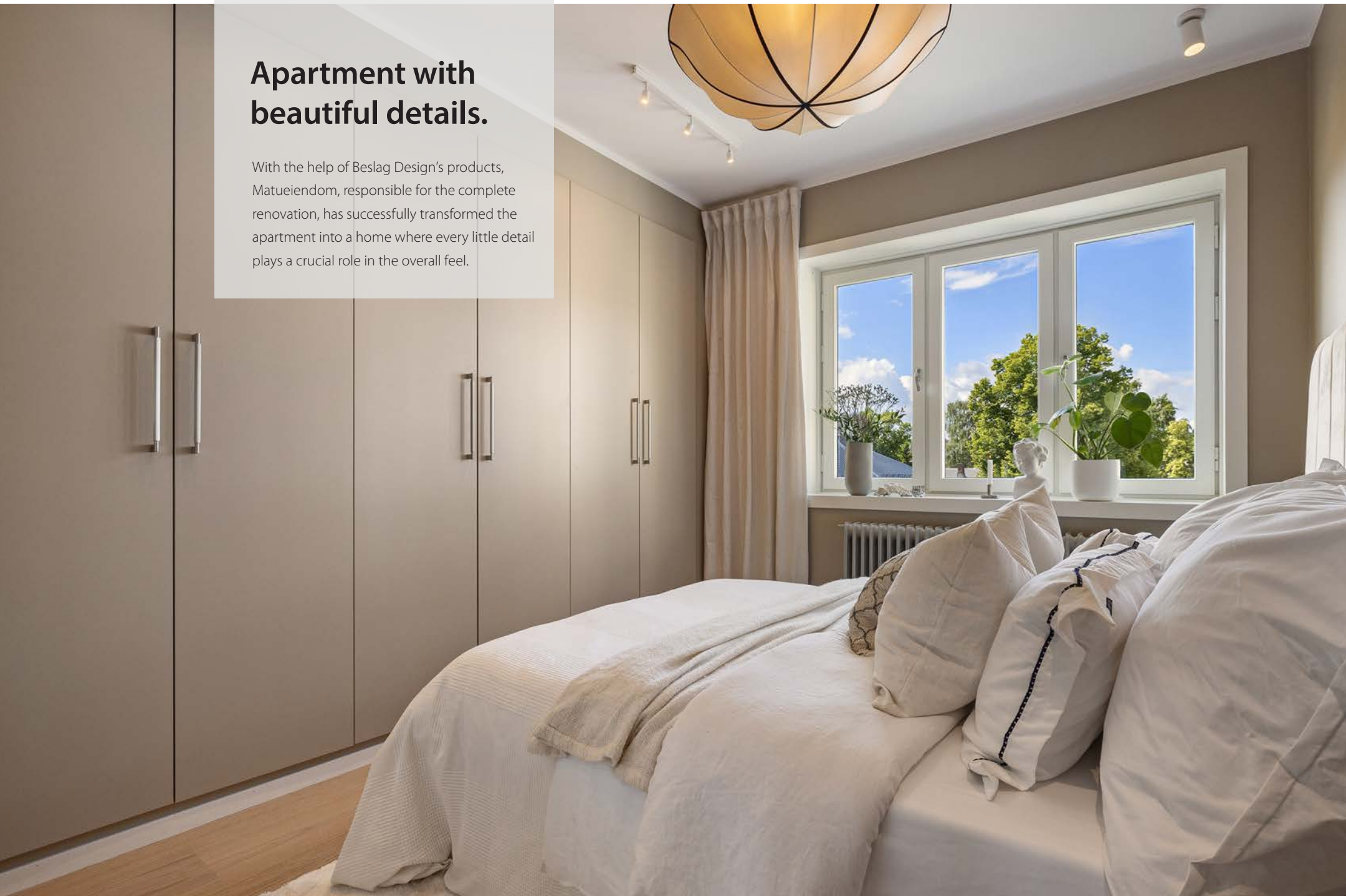

Photo: @matueiendom

Read more about the details on the next page.

Apartment with beautiful details.

With the help of Beslag Design's products, Matueiendom, responsible for the complete renovation, has successfully transformed the apartment into a home where every little detail plays a crucial role in the overall feel.



This stunning apartment in Majorstuen, Oslo, has undergone a complete renovation in 2024 with a focus on quality and design, carried out by our partner Matueiendom. Welcome to an apartment where every detail has been thoughtfully considered, and nothing has been left to chance.

Photo: @matueiendom

Renovation and Design: Matueiendom

A kitchen with thoughtful details.

In the kitchen, our Uniform knobs and Arpa handles become an integral part of the modern and sleek interior. Here, the discreet meets the prominent, creating a calm space where light surfaces and wood interact harmoniously. The vaulted lighting, the shelf with an LED strip underneath, and the light accents in the open cabinetry of the kitchen island enhance the overall modern design.



Stainless steel look

Handle Arpa. Art no 373070-11

Door handle Helix 200 Stripe. Art no 752013-41

Door stop Helix Strip. Art no 753113-41

Arpa is an elegant series with an industrial character, defined by its ribbed surface with subtle stripes. The series includes handles and T-knobs, with or without a backplate, and the handles are available in three different lengths. Arpa comes in four finishes: stainless steel look, brushed brass, brushed black, and antique brass.



Knob T Uniform - Nicel plated
Art no 343296-11

Feskekörkan reopened in Gothenburg

Feskekörka now welcomes visitors to a new, vibrant meeting place where classic craftsmanship meets modern design.



An impressive transformation.

After four years of extensive renovation, Göteborg's iconic Feskekörkan reopens its doors to the public. 2024 marks a new era for this classic landmark, now upgraded into a modern destination with a range of new features: fish counters, a bar serving schnapps on tap, three restaurants, and extended opening hours into the early morning.



With elegant LED lighting integrated into the bar counters and restaurants, a warm and inviting atmosphere is created that highlights the space and the beautiful details of the building.

LED-strip Flexy LED SE H4-24

An extremely thin and flexible LED strip, ideal for installation in wardrobes, bookshelves, and cabinets. Made of soft silicone, it can be easily pressed into milled grooves without the need for additional fastening. It fits grooves with a width of 4 mm and a depth of 8 mm, and features dual connections for easy installation. The only limit is your imagination – Flexyled SE H4-24 can be used in straight, curved, or circular grooves and is easily pressed into place.



LED-strip Flexy LED SE H4-24 under bardisken är en spännande och smart lösning.

Colorful

KNOBS

Choosing colorful knobs for your kitchen and home is an easy and effective way to add a personal touch to the room. Colored knobs can create exciting contrasts, elevate a neutral interior, and bring energy to the space. Whether you opt for subtle, earthy tones or bold colors, the knobs can transform the overall impression and contribute to a harmonious or dynamic atmosphere.

Colored knobs also provide an opportunity to tie together various design elements in the home, such as walls, textiles, or other interior details. They are a versatile tool for expressing style and personality, and by choosing the right shades, you can easily alter the room's character without major changes.



KNOB COLETTE



KNOB KEY



KNOB CLASSIC



KNOB UNIFORM



KNOB T VIVA



KNOB COLETTE



KNOB SKYE



KNOB UNO



KNOB T VIVA



KNOB T SKYE



KNOB BEAD STRAIGHT



KNOB T VIVA



KNOB COLETTE



KNOB T VIVA



KNOB SKYE



KNOB STURE



Customize your lighting



Mini spotlight Pixel

If you're looking for something special, choose Pixel for a truly striking light. Pixel is a small, compact spotlight perfect for placement in display cabinets. Designed for recessed installation, it can be mounted in both through-holes and concealed holes with a diameter of 30 mm. The symmetrical light projection provides even illumination that highlights details and creates a pleasant atmosphere.

- The perfect mini spotlight for display cabinets
- Recessed installation
- Mounts under cabinets or shelves

Mini spotlight Pixel
Black. Art no 971103

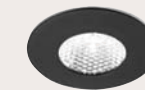

In the display cabinet
LED-profile LD8104 – Black. Art no 973500

Under the cabinet
LED-profile Nexus – Aluminium. Art no 973580

Kiny Black
Wireless switch/dimmer – Double. Art no 99096

Uniform
Burnished brass - c/c 128.
Art no 343305-11

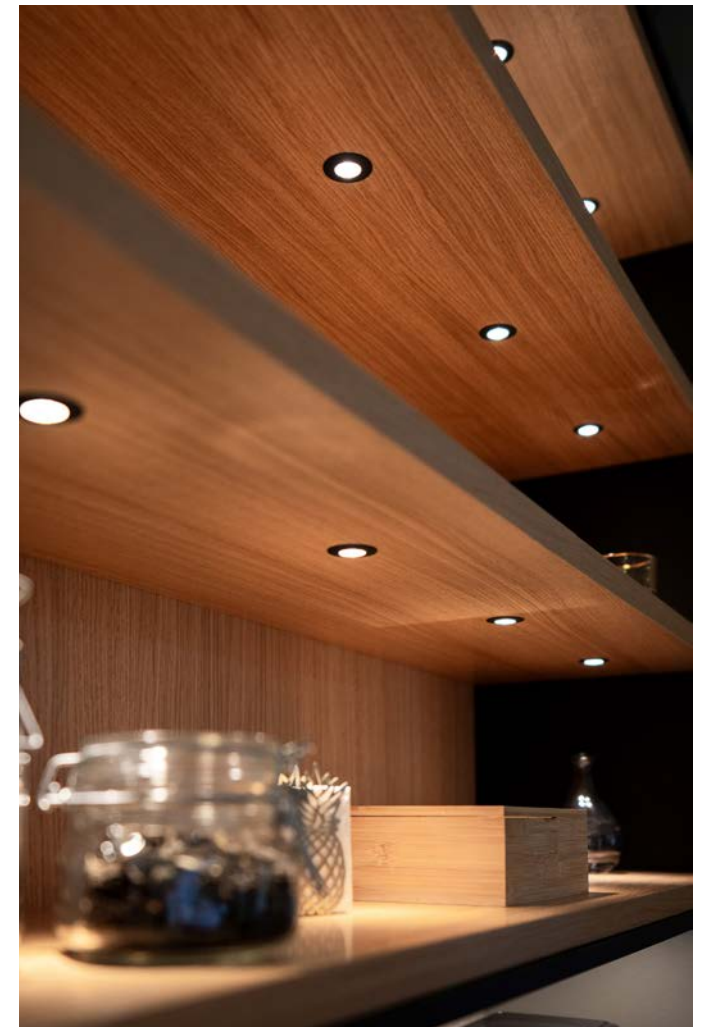

BATHROOM

A BATHROOM TO ENJOY

Create your own calming sanctuary in the bathroom, where every detail reflects your unique personality. Our range of knobs, handles, door pulls, hooks, lighting, accessories, and storage solutions are designed to stand the test of time, maintaining their style day after day, year after year.

Whether you prefer the latest in design or timeless elegance, we have everything you need to craft your very own retreat. Let the bathroom be a place where you can relax and allow your personality to shine through every detail.

SELF-ADHESIVE DESIGN FOR EASY INSTALLATION.



Why drill holes when you don't need to? The Base bathroom series features a self-adhesive backing for easy installation, making it an excellent choice for wet areas where drilling may be problematic.

In the Base series, we offer everything from self-adhesive bathroom hooks to shelves, towel rails, toilet paper holders, and toilet brushes. All products are designed to complement each other, making it easy to create a cohesive style in your bathroom.

The Base bathroom series is available in a range of sophisticated finishes, including polished chrome, brushed stainless steel, matte black, and brass. Take advantage of this color variety to create a bathroom that reflects your personal taste.

Images below:

1. Base - Soap dispenser holder - Brushed stainless steel - 606080-41
2. Knob T Viva - Brushed stainless steel - 304401-11
3. Base - Shower shelf - Brushed stainless steel - 606070-41
4. Base 200 - Toilet paper holder - Brushed stainless steel - 60604-21
5. Base - Hook rail with shelf - Brushed stainless steel - 606066-41
6. Base - Toilet Brush - Brushed stainless steel - 620030



1.



2.



3.



4.

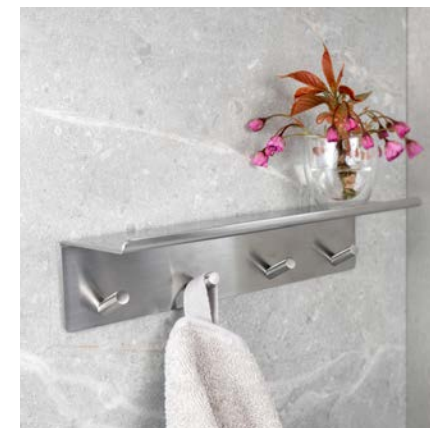

5.



6.

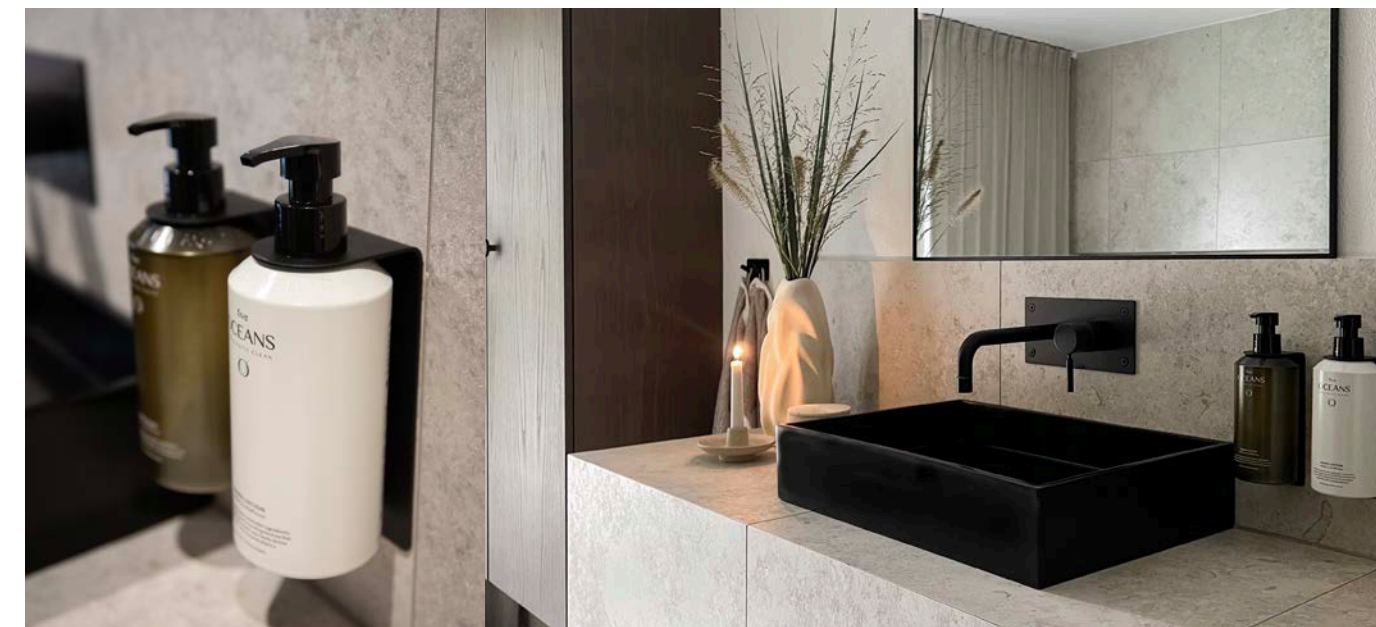

A bathroom with style.

This beautifully designed bathroom, featuring grey and sand-colored tiles combined with black details, a shower, and faucets, along with natural tones, creates a tranquil atmosphere.

Our wall-mounted soap dispenser holder elevates the bathroom's style even further. Perfect for freeing up space on the sink from soap bottles or keeping shampoo bottles off the shower floor – a tasteful detail that immediately brings order and harmony. It installs easily without tools thanks to its self-adhesive backing. Also, explore our other bathroom accessories in matte black.

Photo: @mathildasinterior

Matte black

Base Soap pump holder. Art no 606081-41

Base Shower Squeegee with holder. Art no 606055-41

Base 200 – 2-hook. Art no 605222-21

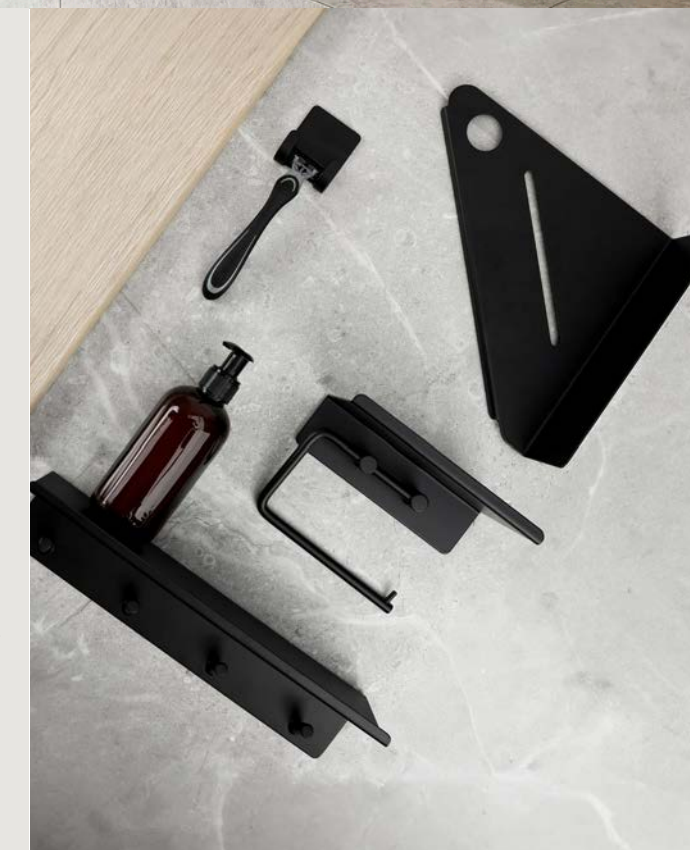



TIMELESS BEAUTY

In this elegant bathroom, you are surrounded by timeless beauty and refined material choices. Gray marble adorns the walls and floor, creating a luxurious atmosphere, while gray cabinet fronts add a harmonious and modern touch. Bathroom accessories in chrome – from faucets to towel hangers – provide a sophisticated shine that contrasts with the soft gray tones, elevating the room to a new level. Every detail has been carefully selected to create a bathroom where both design and function work together seamlessly.

Photo: @34kvadrat

Base

More and more people want every detail in their home to reflect their style – even in the bathroom. With more color options, new possibilities arise to furnish in a personal and elegant way. Our sleek Base series combines function and design, with a core of stainless steel and finishes such as polished chrome, brushed stainless, brass, and black. All products feature a self-adhesive back, making them easy to install – no drilling required.

Here, you can see Base paired with the Brohult M handle in a bright, harmonious bathroom with marble, at @34kvadrat.



Polished chrome

- Base Toilet roll holder. Art no 60603-21
- Base Soap pump holder. Art no 606082-41
- Base Toilet brush. Art no 620010
- Base 1-hook. Art no 60408-21
- Base Towel rail pole. Art no 606046-21
- Handle Brohult M - 128 mm. Art no 397045-11

Matte black

Details for a sleek and cohesive expression.

Matte black is a hue that combines sophistication and subtle strength, making it ideal for accentuating the details in a room. In interior details, matte black creates a bold yet understated contrast, fitting both modern and classic environments. The matte finish adds a sense of luxury and exclusivity without overwhelming the space – it's there to enhance and complement.

With matte black handles, knobs, or fittings, you can create a stylish whole where the details take center stage. This hue is especially popular in kitchens and bathrooms, where it brings a minimalist, industrial look that feels both functional and elegant. Matte black details are more than just a trend – they represent a thoughtful choice for those wanting to add a touch of drama and depth to their home.

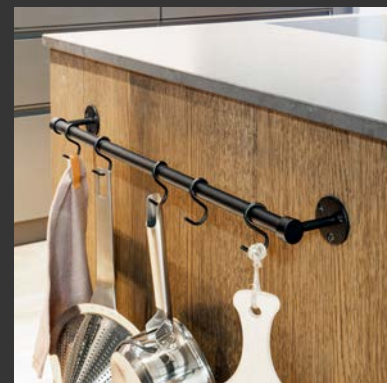
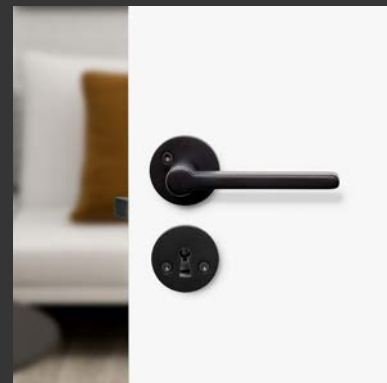

At Beslag Design, you'll find a wide selection of products in an elegant matte black finish – from handles and knobs to hooks, door handles, and bathroom accessories. Each product is carefully designed to easily combine and create a cohesive, sleek look throughout your home.

With our matte black interior details, you can give every room a distinct sense of modern style. Choose matte black for a harmonious blend of functionality and design, whether you're updating the kitchen, bathroom, or entrance. Matte black from Beslag Design is a conscious choice for a home where every detail matters.

1. DOOR HANDLE MONZA 2. DOOR STOP BUGGY 3. POWEE OUTLET INFINI 4. BASE HOOK RAIL WITH SHELF 5. BASE TOILET PAPER HOLDER 6. BASE 200 2-HOOK 7. AVENY KITCHEN RAIL 8. KNOB SPIRA 9. HANDLE VIVA 10. KNOB T OLIVER 11. FURNITURE LEG FONDA 12. HOOK BELT 13. HOOK NISSAN

HALLWAY

A WARM WELCOME

The hallway is the home's first room
– a reflection of who you are.

Make a statement with both design and function.
A stylish hallway with smart details for everyday moments.
Handles, lighting, accessories, and storage. For the family
with kids, the aesthete, the bohemian, and the minimalist.

Small details that make a big difference
– for every style and personality.



"We decided to replace our door handles with ones of much higher quality. Our old ones squeaked too much and felt too loose. With the new ones from Beslag Design, they feel more exclusive and have a soft, comfortable grip. And now I don't have to hear that annoying squeaking anymore! These door handles are Sintra — with a stainless steel look."



Blue x Nickolay
@niblu.home

"It is an honor to be an ambassador for Beslag Design. We are truly excited about this opportunity, especially since our friends who have products from Beslag Design have been so pleased with both the service and the quality of the products. The high quality and minimalist design align perfectly with the look and feel we strive for in our home. This is one of the reasons that sparked our interest in becoming ambassadors for Beslag Design."

Photo: @niblu.home



Modern door handle with a comfortable grip

Sintra in stainless steel look is an elegant door handle that combines sleek and soft lines, offering a comfortable grip. Perfect for all interior doors. The handle features a spring return mechanism, ensuring it always returns to its original position. The screw fittings are discreetly hidden for a clean, sophisticated appearance. Available in two finishes: matte black and stainless steel look.

Sintra
Stainless steel look
Art no 752034-41



Dark bronze



HELIX 200
PLAIN - HELIX - STRIPE

Helix door handles and door stops

Our door handles in the Helix 200 series are spring-loaded, ensuring the handle always returns to its original position. You can choose between Helix 200, Helix 200 Stripe, and Helix 200 Plain.

Pair them with the Toalettved R and matching door stops for a cohesive look. The Helix series is available in both Scandinavian and European standards, as well as with modular locks, making them suitable for all interior doors.

The series comes in five finishes: matte black, antique bronze, brass, stainless steel look and dark bronze.

Helix



Helix Stripe



Helix 200

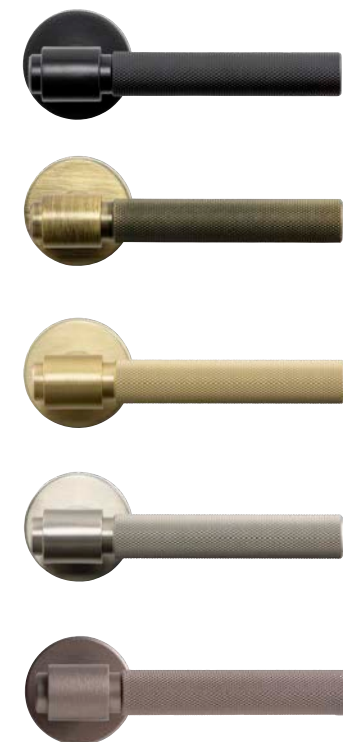

Helix 200 Stripe



Helix 200 Plain



All our door handles come with a keyhole escutcheon and a complete mounting kit. Discover more of our door handles on our website: beslagdesign.com



“It’s the details that make a home and create that luxurious, well-thought-out feeling.”

“It feels truly honorable and exciting to be part of representing Beslag Design! It’s the details that make a home and create that luxurious, well-thought-out feeling. That’s something I want to help convey – and bring even more into my own home together with Beslag Design!”



@hemmahosfalk

INTERIOR DESIGNER AND CREATOR

Photo: @hemmahosfalk



Stainless steel look

Door handle Helix 200 Plain. Art no 752016-41
Toilet thumb turn R. Art no 751113-41



Aveny Kitchen rail

Complete – Oak/Brushed stainless steel – 600 mm
Art no 947960-41



Each rod is unique and can be customized with oil, lacquer, or paint to match your kitchen design. Treatment extends its lifespan and preserves its natural beauty.



Hook Luv

The wall hook Luv is an elegantly designed detail that combines aesthetics and functionality. Luv is available in several different finishes and offers a versatile and stylish hanging solution. With Luv, you not only get a practical solution but also a design that enriches your interior and helps enhance your personal style. Its compact style makes it a perfect choice for small spaces like hallways, bathrooms, and bedrooms.



Brushed brass. Art no 373136-21
 Matte black. Art no 373138-21
 Matte white. Art no 373137-21
 Stainless steel look. Art no 373135-21

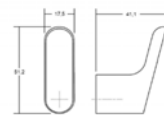

Hook Belt

The ergonomic design and unique shape of Belt allow you to hang multiple accessories simultaneously. Belt is available in six lovely colors, providing you with the opportunity to create endless combinations that bring life to your interior and create harmony. Belt is designed with a focus on durability and robustness, making it a reliable companion in your everyday life.



Matt white. Art no 373125-21
 Matte black. Art no 373126-21
 Gray. Art no 373127-21
 Forest green. Art no 373128-21
 Brown. Art no 373129-21
 Volcano red. Art no 373130-21

Hook Caligola

Caligola is an impressive hook with a generous diameter of 50 mm, making it the perfect addition to various rooms. The Caligola hook is available in several colors that elegantly harmonize with each other. Its surface has been treated with a silk effect, providing a delightful soft feel while also resisting fingerprints and grease stains. A hook that both impresses and simplifies your everyday life



Sand. Art no 590060-21
 Green. Art no 590061-21
 Black. Art no 590062-21
 Zink. Art no 590066-21
 White. Art no 590063-21
 Gray. Art no 590064-21
 Dark brown. Art no 590065-21

CALIGOLA

– a hook that impresses



TONITON

A NEW COLOR PALETTE FROM TONITON

Our collaboration with TONITON makes it a little easier to add color to your home. The handles and knobs are designed in timeless colors that can be combined with faucets, cabinet doors, lamps, and wall paints from TONITON's balanced product palette. If you haven't considered colorful cabinet doors, the hardware makes a beautiful accent when paired with natural materials like oak and walnut.

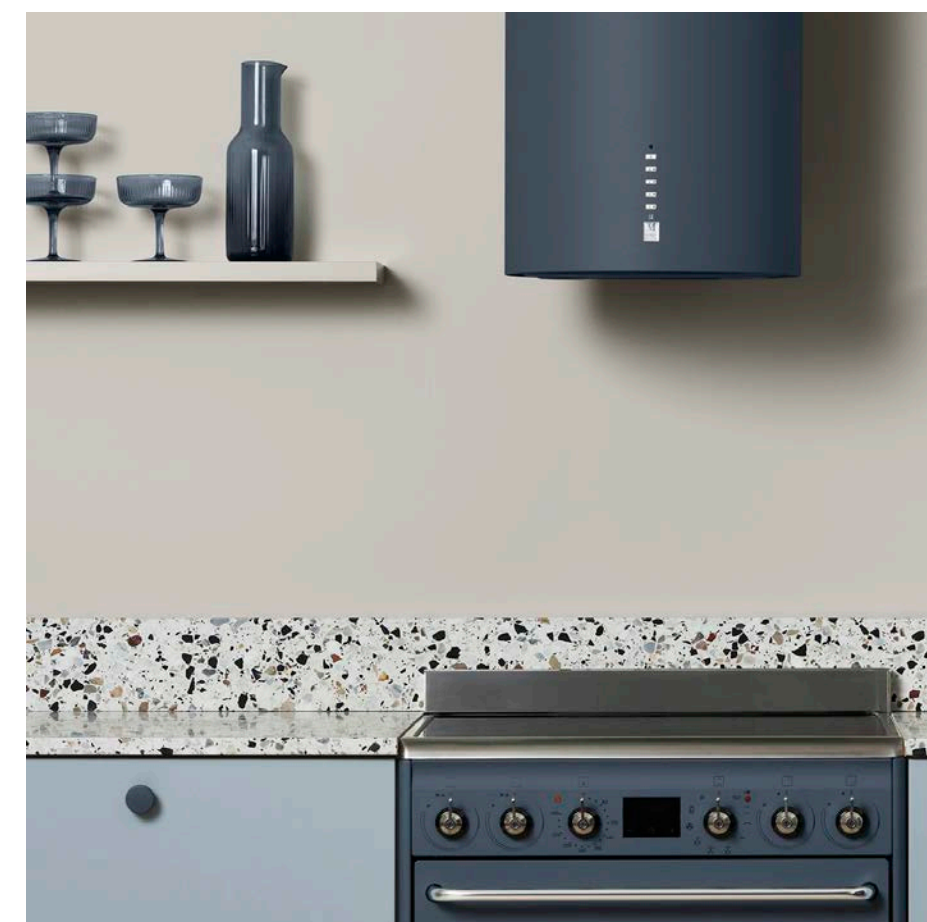

Greige



Reddish Brown



Ash Green



Deep Blue

Details that matter

R O O M • K I T C H E N • B A T H R O O M • H A L L W A Y

In our website you will find handles, fittings, accessories, legs, and lighting for all rooms. For home, store, office, restaurant, and hotel. Details that lift the interior and complete the big picture. Small details make a big difference. Details that you can look at and use over and over again. Down to the smallest detail.



beslag design

beslagdesign.com